

Schizophrenie

Prof. Dr. med. Sebastian Walther

Universitätsklinik für Psychiatrie und Psychotherapie Bern

Fokus Psyche

21.09.2022

Definition von Schizophrenie

Was ist gespalten?

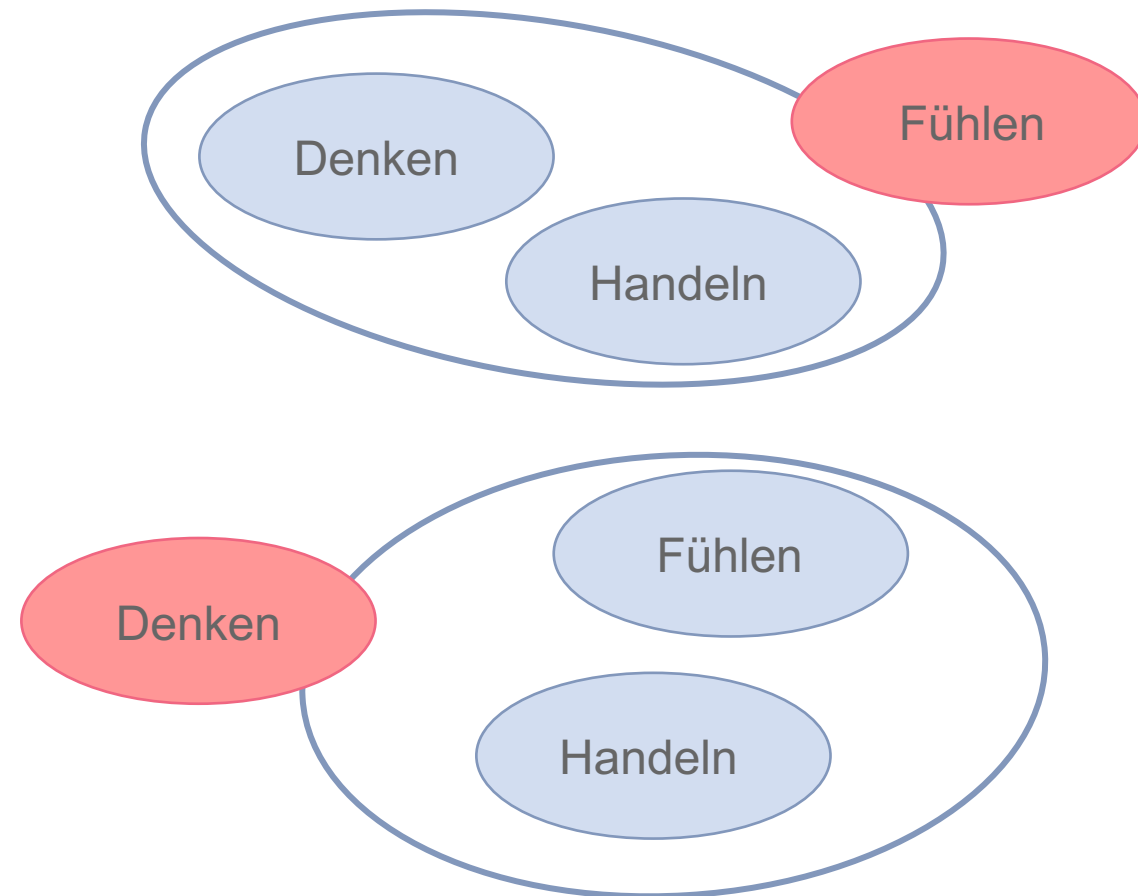
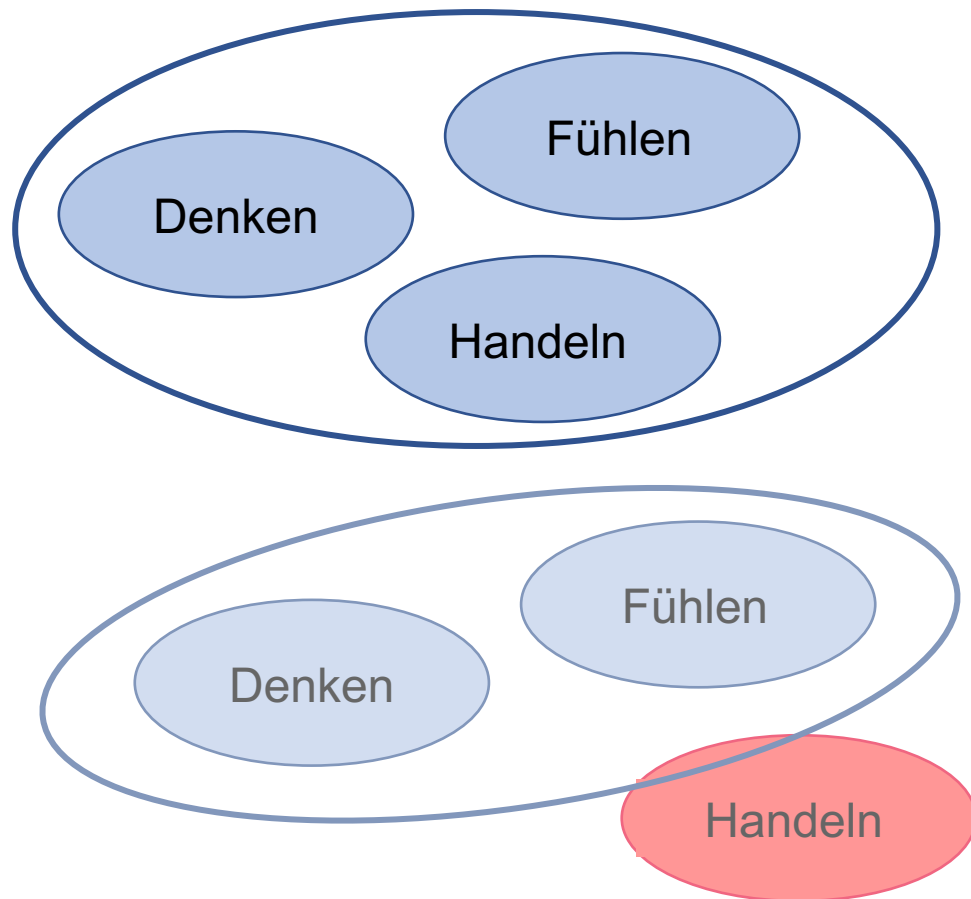

Die Symptome der Schizophrenie

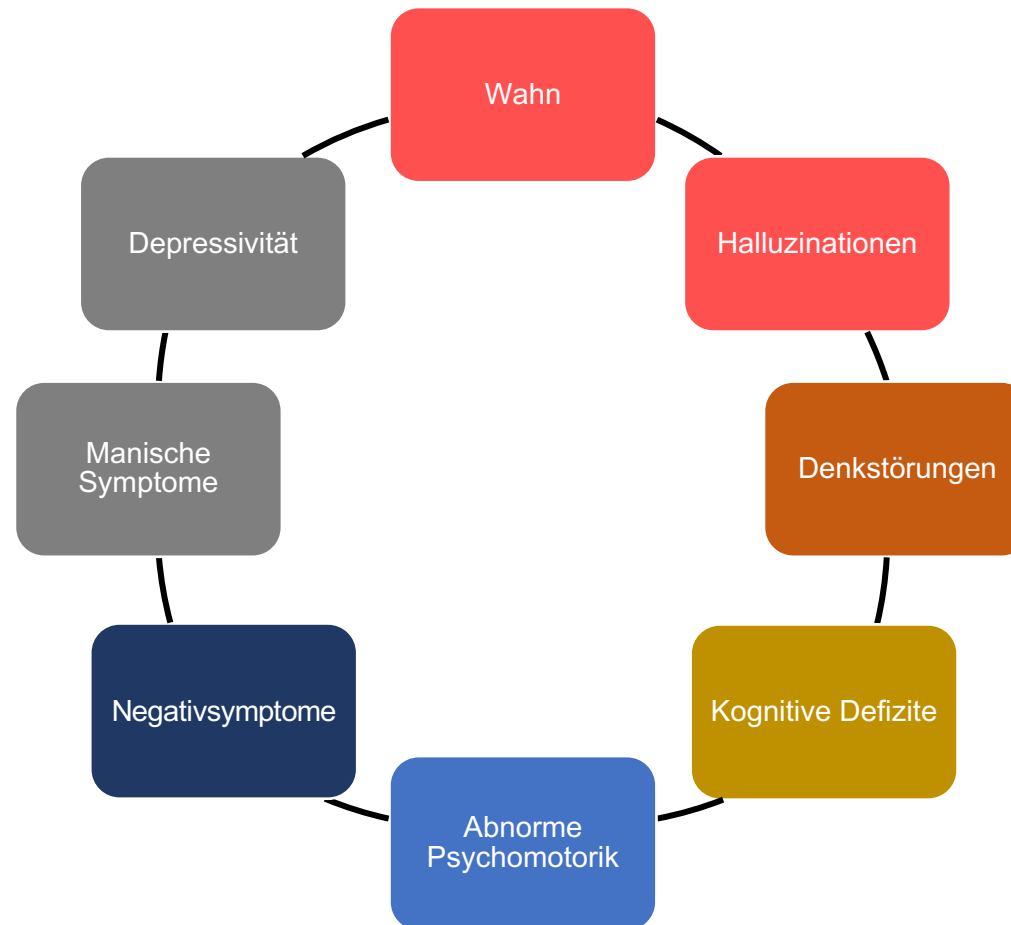

Unterschiede zwischen den Geschlechtern

Frauen mit Schizophrenie

- erkranken später
- sind häufiger in Behandlung
- haben seltener chronische Verläufe
- sterben seltener vor ihrer Zeit

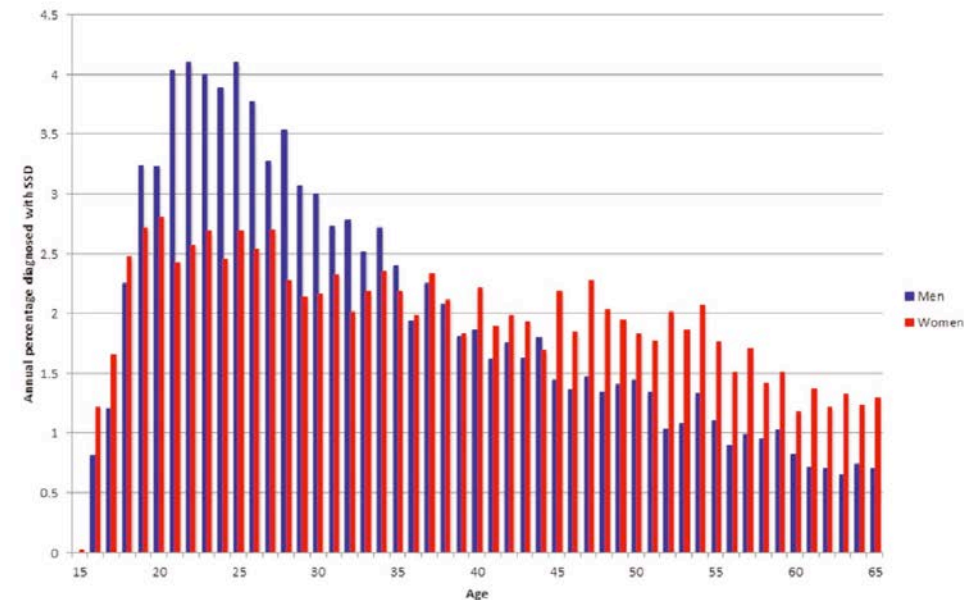
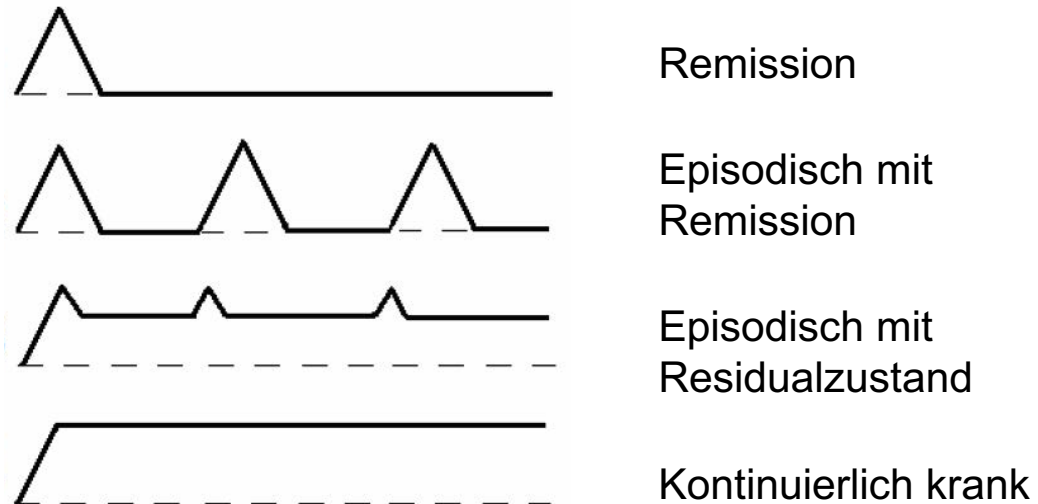

Fig. 3 Age at diagnosis of schizophrenia-spectrum disorder. Age of first recorded schizophrenia-spectrum diagnosis for men ($n=9006$) and women ($n=7142$).

Schizophrenie

Stark unterschiedliche Krankheitsverläufe



Arbeit im Langzeitverlauf

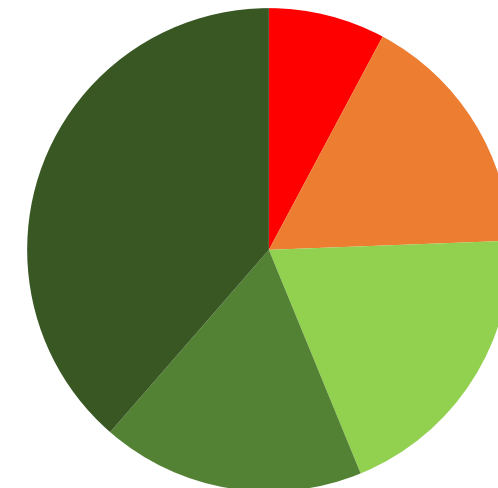

- nicht arbeitsfähig
- erwerbsunfähig
- begrenzt erwerbsfähig
- voll erwerbstätig unter früherem Niveau
- voll erwerbstätig im früheren Niveau

Soziales Funktionsniveau im Verlauf stabil

FIGURE 2. Social Functioning Trajectories Across Psychotic Disorders, Derived From Latent Class Growth Analyses^a

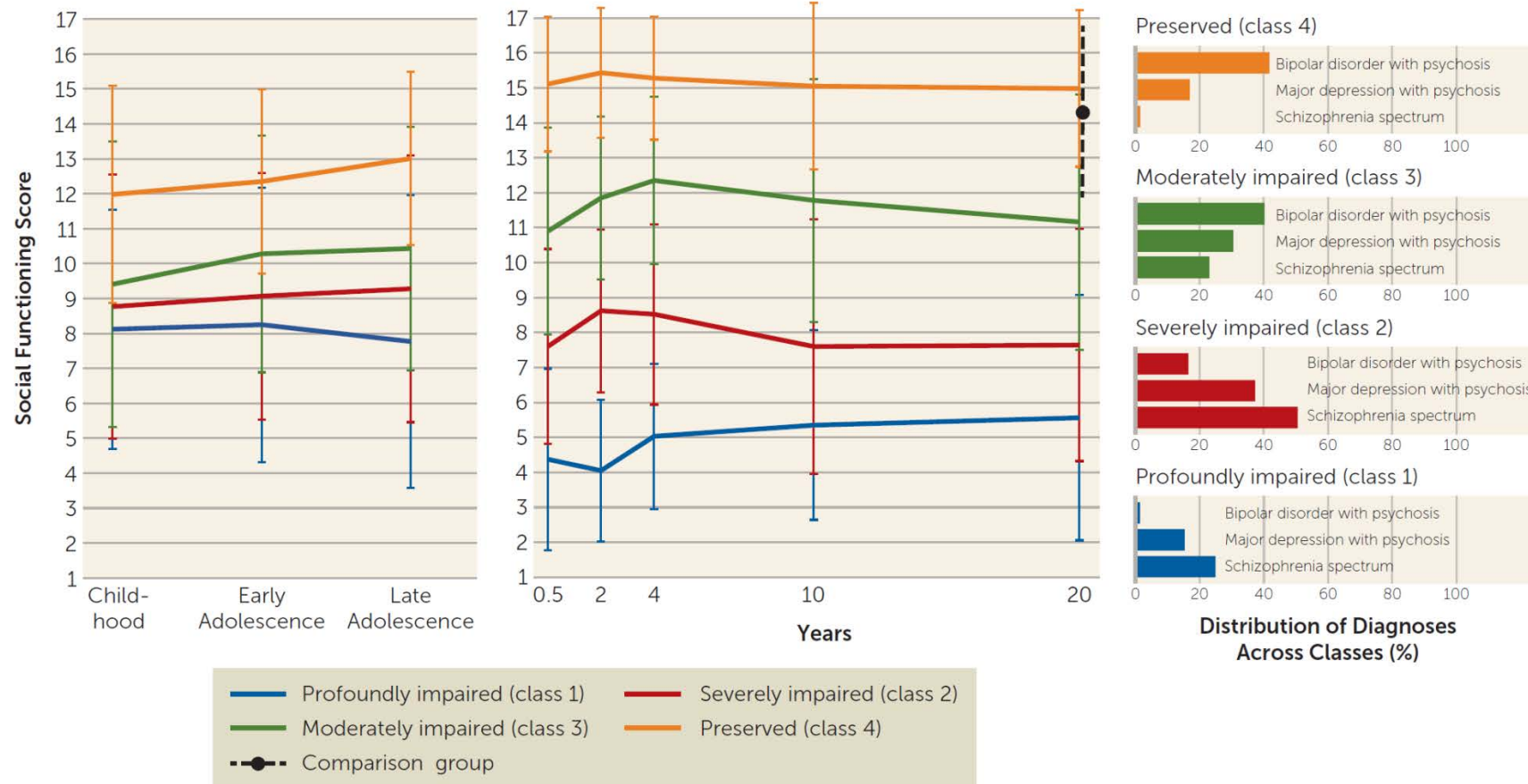

Warum erkranken nur 1% der Menschen?

natureOUTLOOK

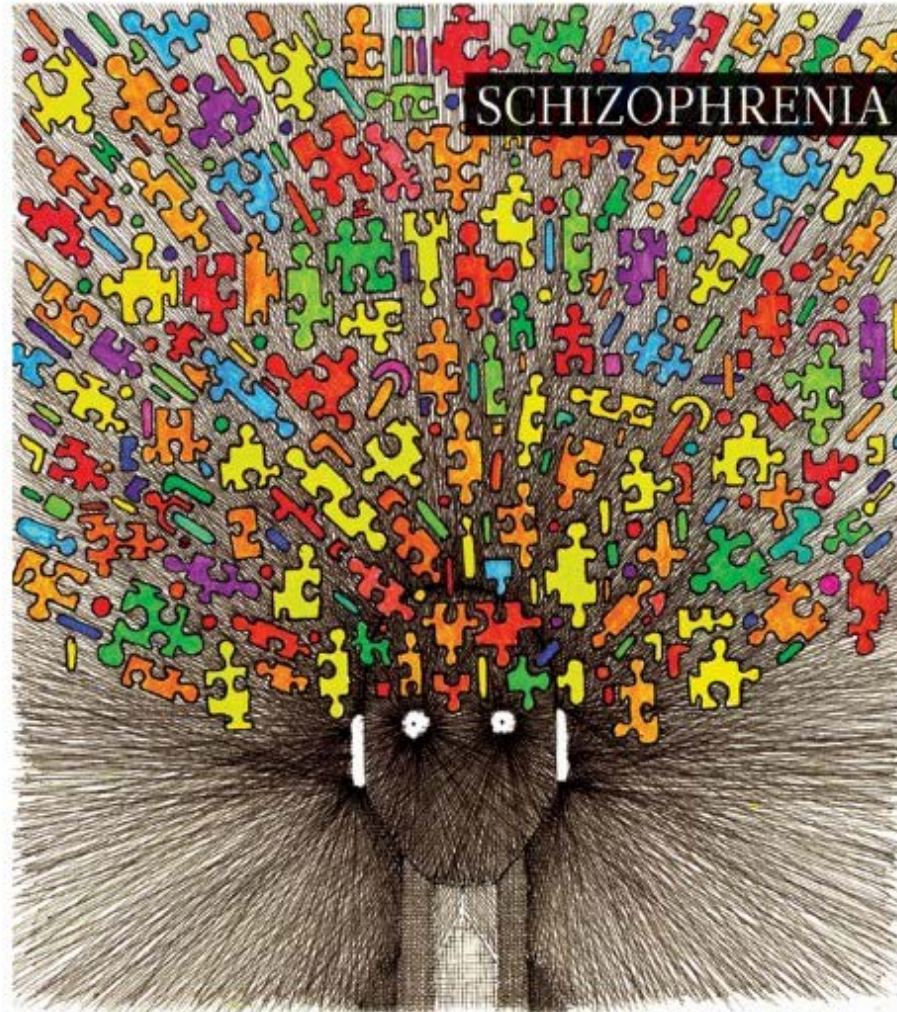

Putting the pieces
together

Verlauf der Schizophreniesymptome

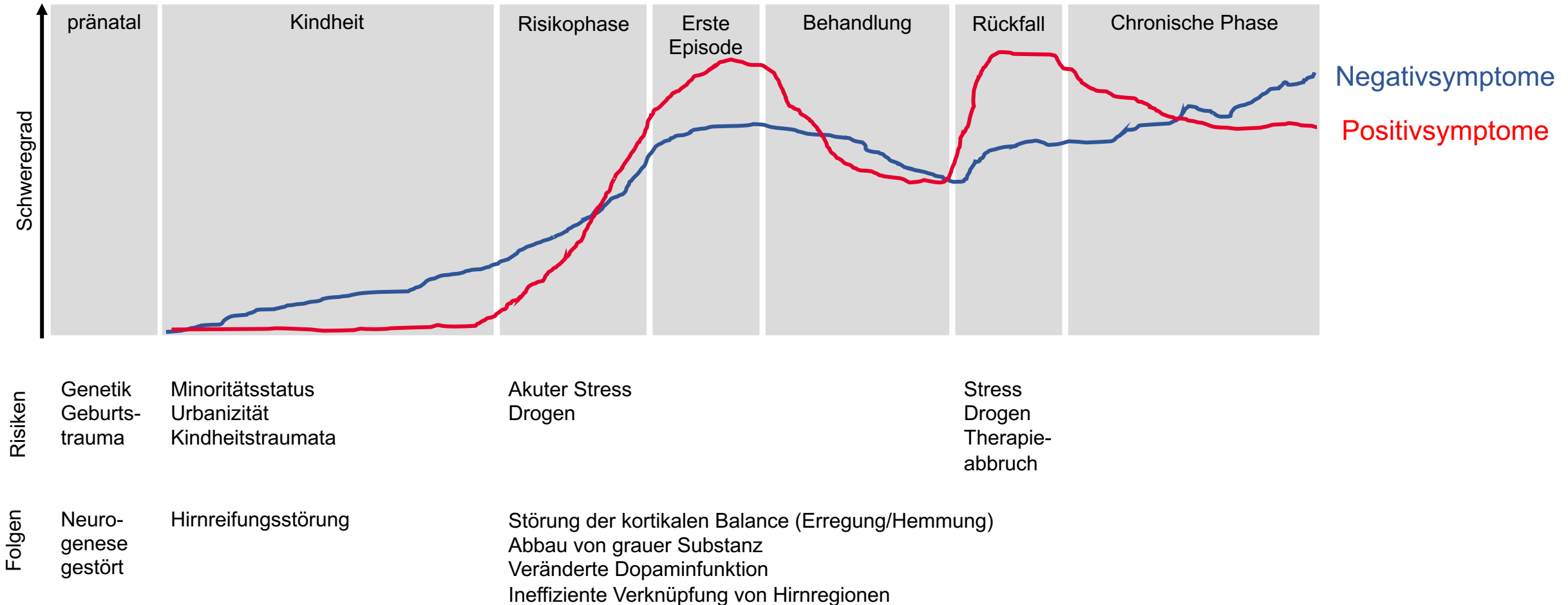



Hirnstimulation

Rehabilitation



Psychotherapie

Case Management



Antipsychotika



UNIVERSITÄRE
PSYCHIATRISCHE
DIENSTE BERN

u^b

b
UNIVERSITÄT
BERN

Was bedeutet die Erkrankung für die Betroffenen?

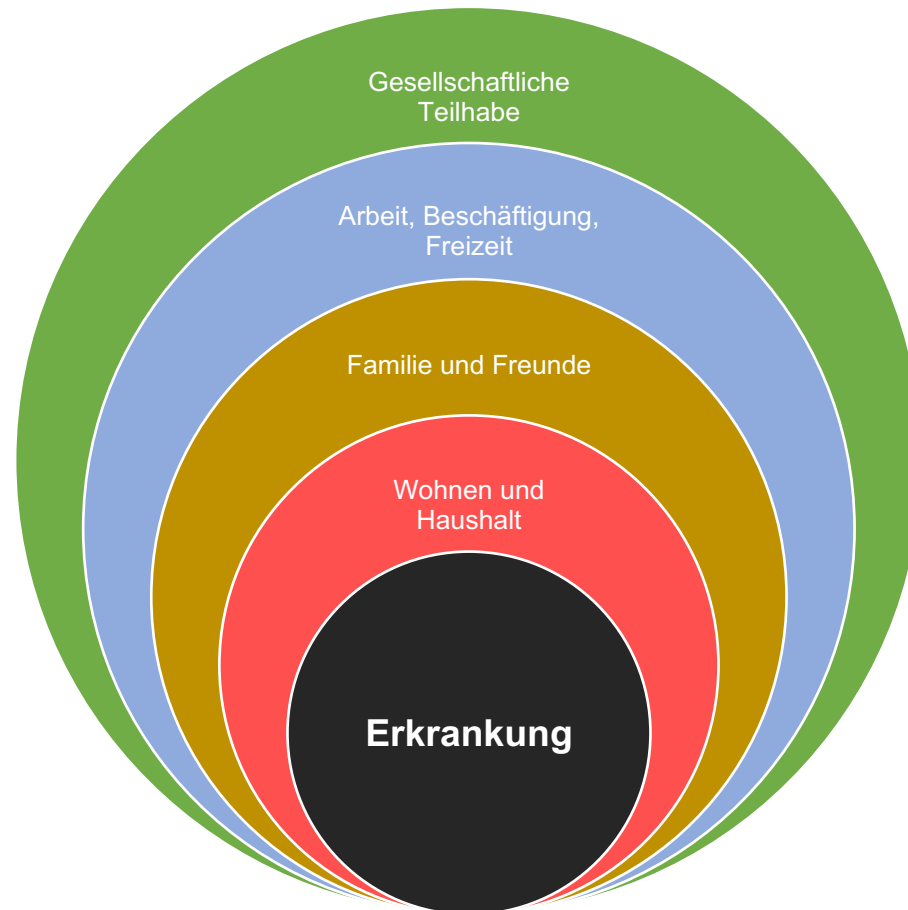

UNIVERSITÄRE PSYCHIATRISCHE DIENSTE BERN (UPD)

Peer-Arbeit in den UPD

Woran wird aktuell geforscht?

Entstehung der Schizophrenie

Neue Psychotherapie-techniken

Vorhersagen des Verlaufs

Neue Substanzen für Medikamente

Hirnfunktionen und Symptome

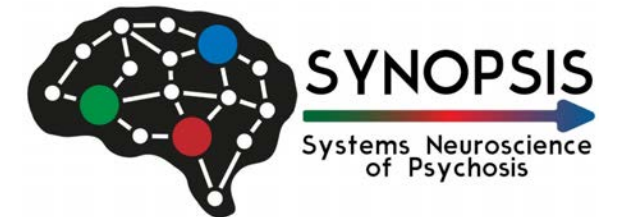

Hirnstimulation

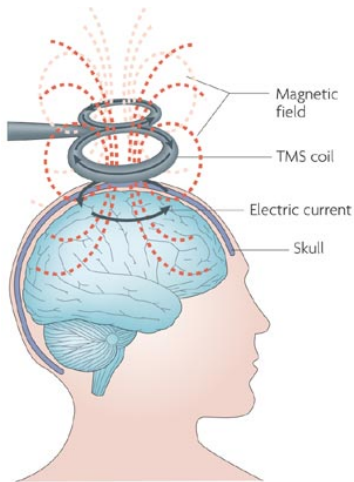

Wirkung gegen

- Stimmenhören
- Negativsymptome
- Verlangsamung
- Defizite in sozialer Kognition

Transkranielle Magnetstimulation

- lokal
- vorübergehend
- spezifisch
- nebenwirkungsarm

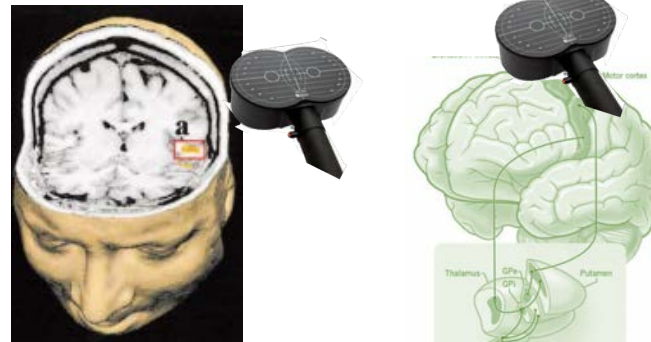

Neue Behandlung für soziale Interaktion

Kombinationstherapie für genauere Gesten

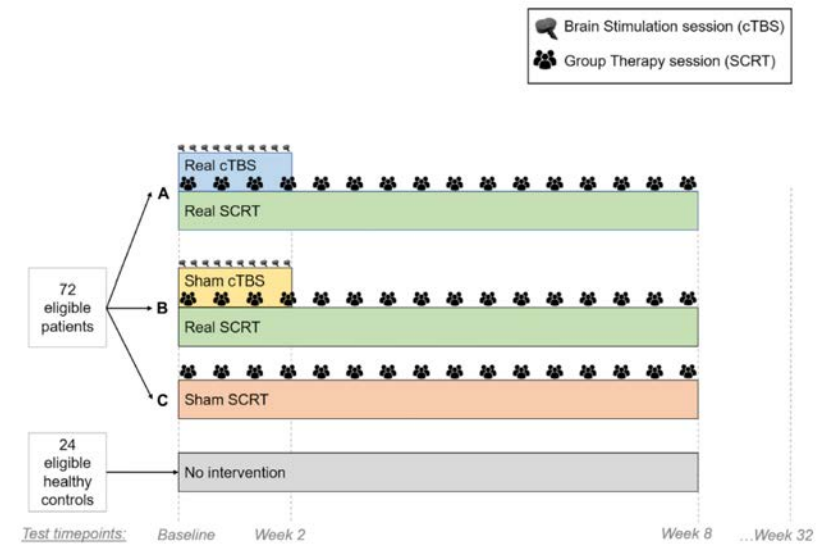
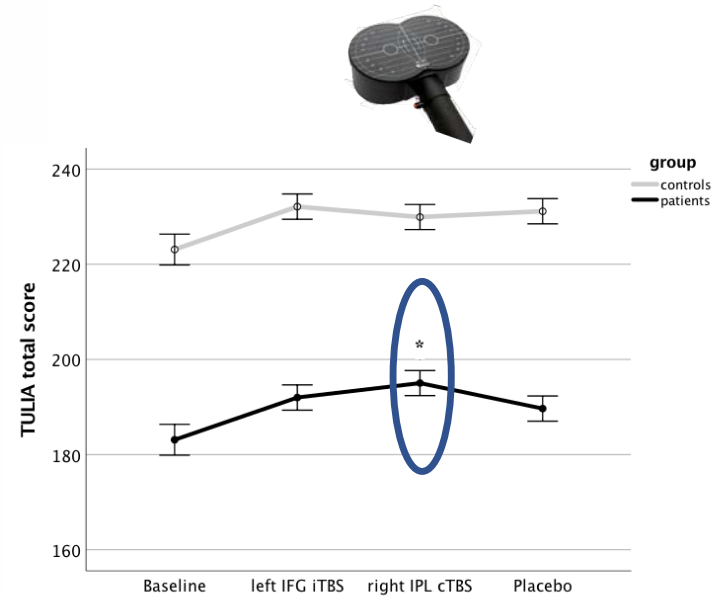
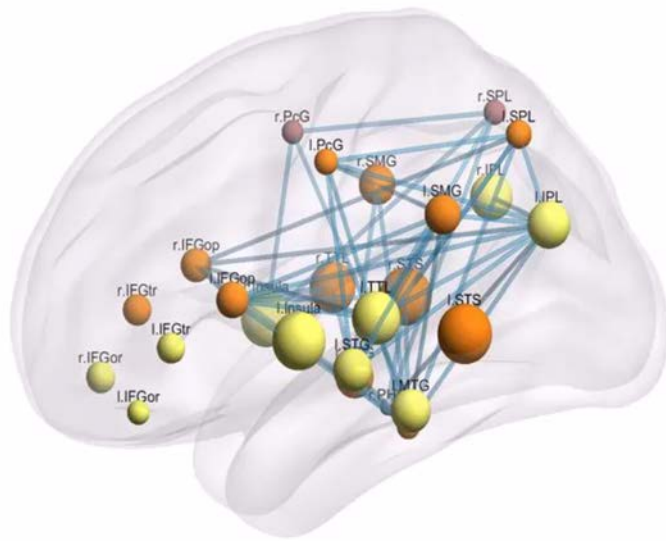

Vielen Dank

